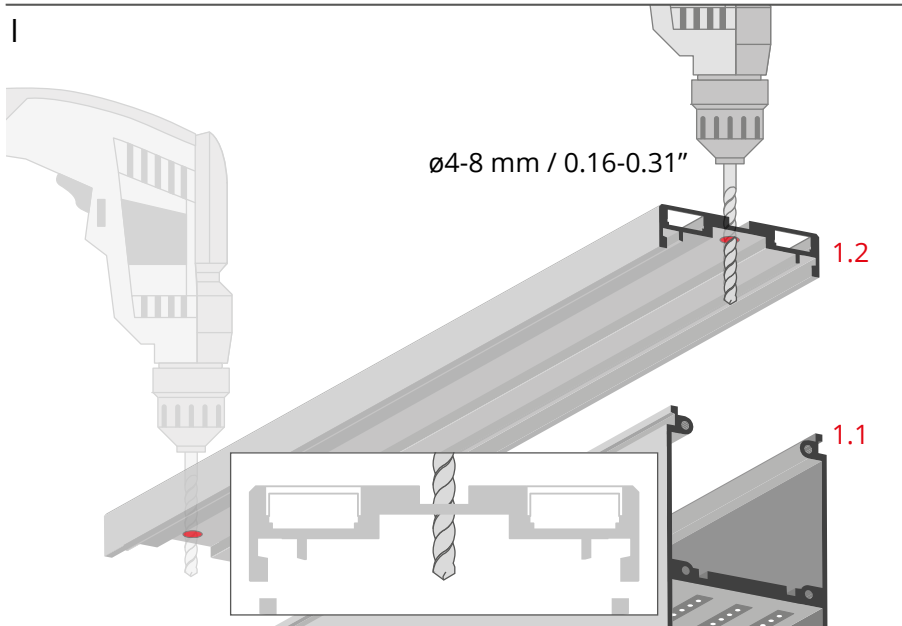
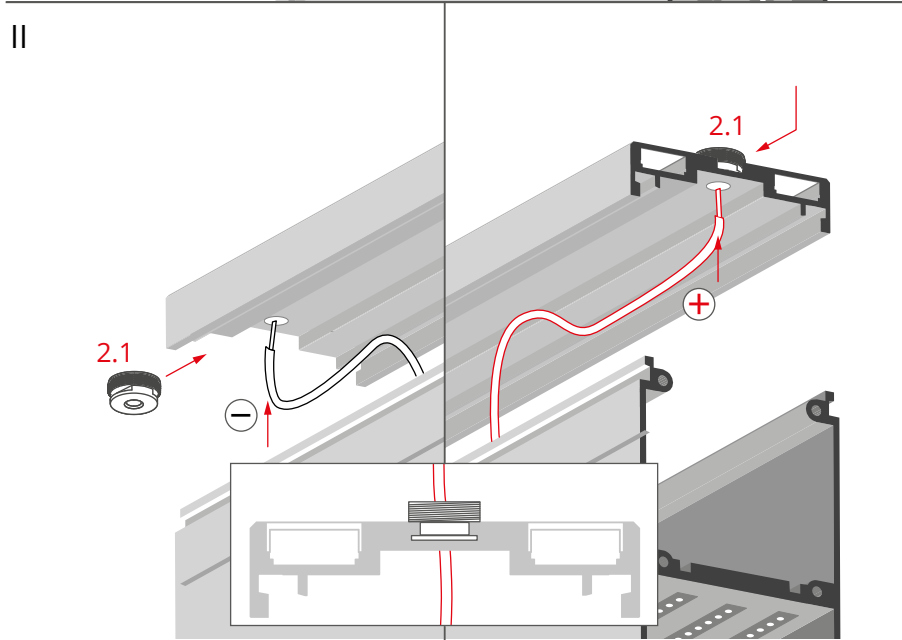
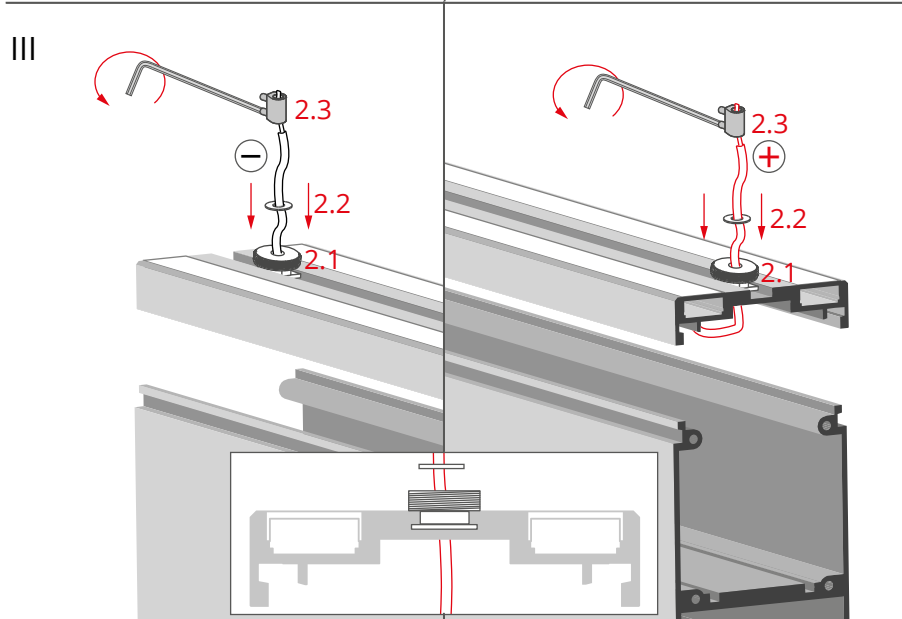

- 1.1 Profile with LED strip
  - 1.2 Mounting track
  - 2.1 Threaded plug
  - 2.2 Washer
  - 2.3 Power connector
  - 2.4 Wire crimp
  - 2.5 Sleeve
  - 2.6 Head
  - 2.7 Fastener body
  - 3. Steel cable\*
  - 4. Ceiling fastener\*
  - 5. Power supply (12 V / 24 V)\*
- } Lighting fixture
- } PUSZ-LIN-ZD silver (ref. 42279), black (ref. 42279L9005)

\*The full range of accessories and electronics is available at [www.KlusDesign.eu](http://www.KlusDesign.eu)

**NOTE!** All LED tapes must be connected to a 12 V or 24 V power supply.

**IMPORTANT:** Not all possible mounting procedures are presented here. More mounting procedures and related accessories can be found at [www.KlusDesign.eu](http://www.KlusDesign.eu). Drawings of extrusions and accessories in these instructions are simplified and only approximate the actual shapes.

<p>I</p>  <p>ø4-8 mm / 0.16-0.31"</p> <p>1.2</p> <p>1.1</p>	<p>Drill holes with a diameter of 4-8 mm / 0.16-0.31" in the back of the mounting track (1.2). One hole per fastener.</p>
<p>II</p>  <p>2.1</p> <p>+</p> <p>-</p>	<p>Set the threaded plug (2.1) in the groove on the top of the fixture and above the pre-drilled hole. Run a cable from one pole of the LED strip through the hole and the plug.</p>
<p>III</p>  <p>2.3</p> <p>-</p> <p>2.2</p> <p>2.1</p> <p>+</p> <p>2.2</p> <p>2.1</p>	<p>Run the cable through the washer (2.2) and into the power connector (2.3). Lock the cable in the power connector with the use of an allen wrench.</p> <p><b>NOTE:</b> In case of an external power cable, skip the power connector (2.3).</p>

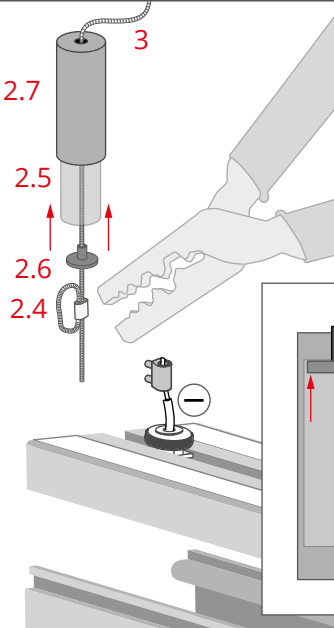
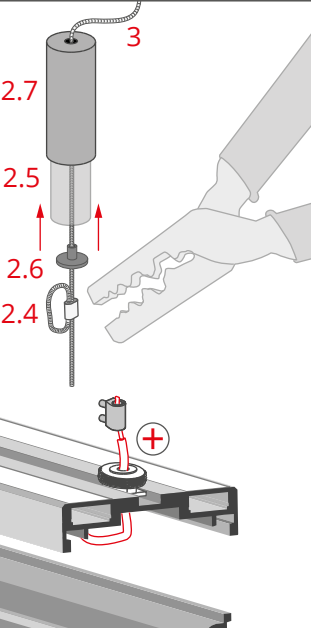
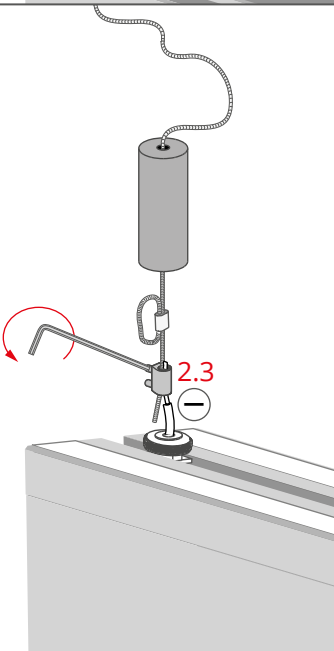
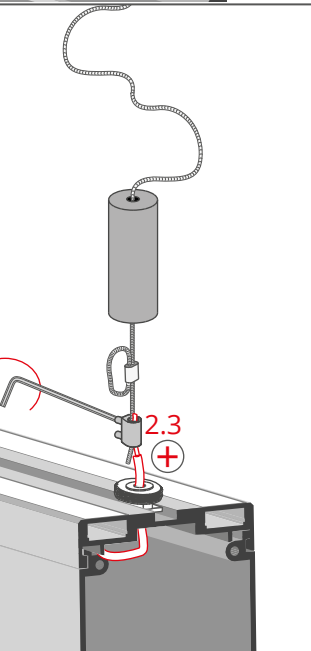
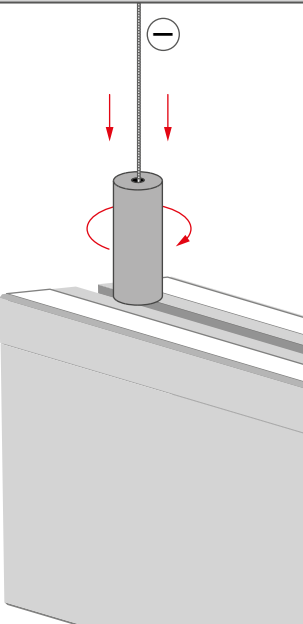
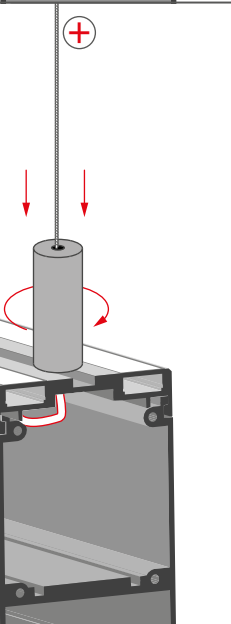
<p>IV</p> 		<p>Insert the sleeve (2.5) and the head (2.6) into the fastener body (2.7) and run the steel cable (3) through it, then run the cable twice through a wire crimp (2.4). Squeeze the wire crimp with e.g. pliers to stop the steel cable from moving.</p> <p><b>NOTE:</b> In case of an external power cable, skip the sleeve (2.5).</p>
<p>V</p> 		<p>Insert the end of the steel cable into the power connector (2.3) and secure it by tightening the screws of the power connector with the allen wrench.</p> <p><b>NOTE:</b> In case of an external power cable, skip this stage.</p>
<p>VI</p> 		<p>Insert the entire assembly into the sleeve and tighten the the fastener body.</p>

VII

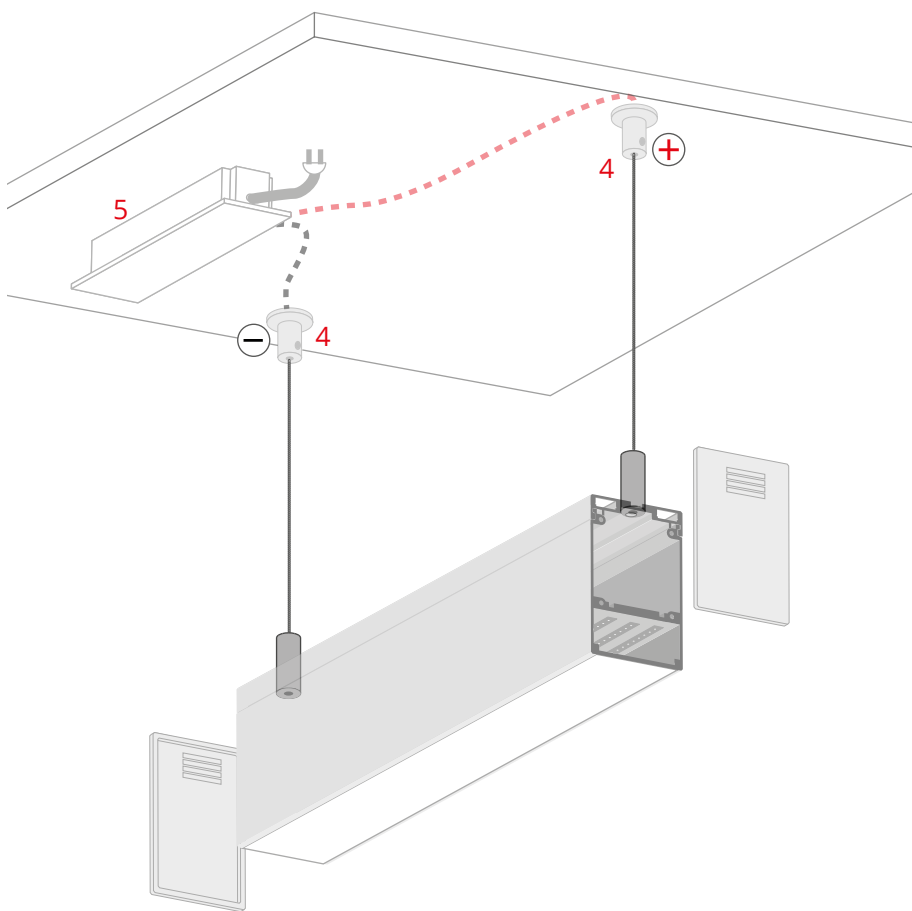

Suspend the lighting fixture from the ceiling fasteners (4) which are connected to the power supply (12 V / 24 V) (5).