

PRODUCT DESCRIPTION

- Designed to reach an IP67 waterproof rating
- A movable insert for LEDs enabling four different lighting angles

FINISH :

Silver anodized

*Custom colors available upon request



Fill empty fields

Product nr.	
Fixture type	
Company	
Job name	
Date	

TECHNICAL SPECIFICATION

Application

- extrusion for construction of surface mounted fixtures with a focused beam of light

Assembly

- with screws appropriately selected for the surface
- with mounting brackets
- with suspension accessories
- with mounting adhesives

Additional information

- possibility of making a linear fixture with IP67 protection, which means the fixture is dustproof and waterproof
- the insert setting adjustment enables 10, 30, 60 and 90 degree beam angles
- spece for LED strip: 11.2 mm

Profile bending

Minimum internal radius	Minimum external radius
150 mm	250 mm

- minimum radius - bending radius which when exceeded causes destruction (deformation, bending or lack of compatibility with other accessories, e.g. covers, end caps, etc.) of the profile
- internal radius - refers to the profile bent so that the cover is facing the inside of the arch
- external radius - refers to the profile bent so that the cover is facing the outside of the arch
- irregular curves are possible after consultation and individual quotation
- when bending anodized profiles, one should be aware of cracking of the anode coating (which may be more or

less visible depending on the radius)

AVAILABLE LENGTHS

Ref. nr.	surface finish	available lengths
B468+43ANODA_1	Silver anodized	1000 mm
B468+43ANODA_2	Silver anodized	2000 mm
B468+43ANODA_3	Silver anodized	3000 mm

TECHNICAL DRAWING

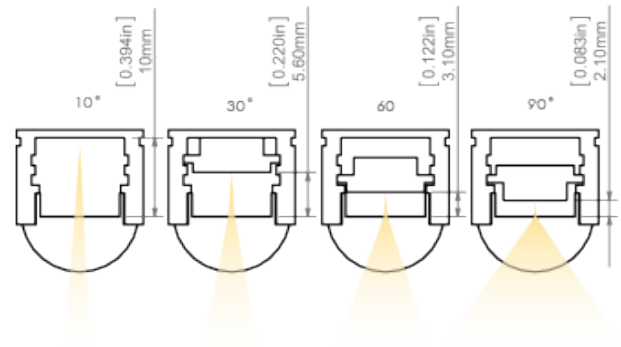
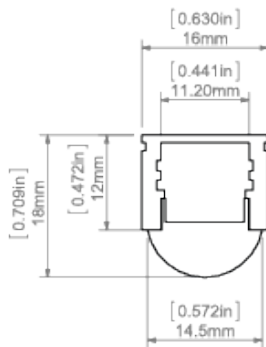

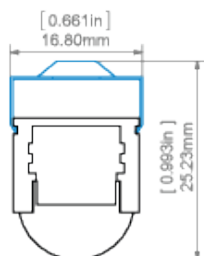

REGULOR profile and PDS-STN mounting bracket
profil REGULOR z mocownikiem PDS-STN

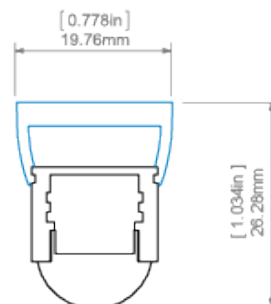

REGULOR profile and PL-PDM mounting bracket
profil REGULOR z mocownikiem PL-PDM

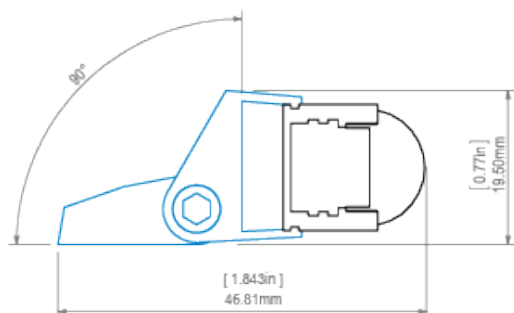

REGULOR profile and REG-PD-UV mounting bracket
profil REGULOR z mocownikiem REG-PD-UV

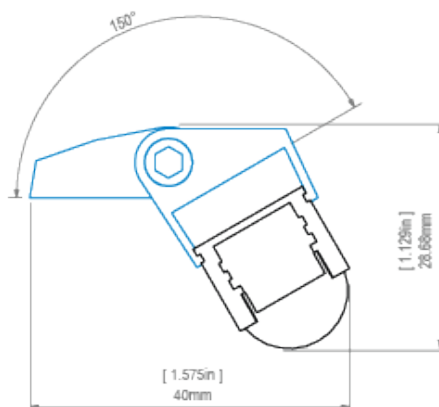

REGULOR profile and REG-PD-UV mounting bracket
profil REGULOR z mocownikiem REG-PD-UV

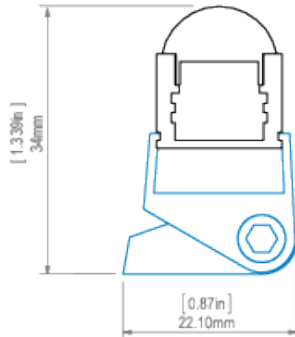

REGULOR profile and REG-PD-UV mounting bracket
profil REGULOR z mocownikiem REG-PD-UV

RELATED PRODUCTS

COVERS

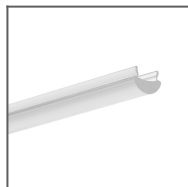

S clear Cover
Ref: 00220

80°

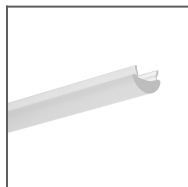

S satin Cover
Ref: 17111

70°



END CAPS



REGULOR grey
End cap
Ref: 00310



REGULOR-OTW
grey End cap
Ref: 00313

ACCESSORIES



8,8x1,2 Gland
Ref: 00802



BZP Head
Ref: 42213



BZP-ZO Head
Ref: 42214



BZP-ZZ Head
Ref: 42215



DP Fastener
Ref: 00644



DP-MOC Fastener
Ref: 00645



DP-MOC-ZO
Fastener
Ref: 00646

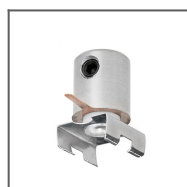

DP-MOC-ZZ
Fastener
Ref: 00647



DP-ZO Fastener
Ref: 00649



DP-ZZ Fastener
Ref: 00651



K5G-AB Arm
Ref: 42051



M11 Fastener set
Ref: 42609



M12 Fastener set
Ref: 42610

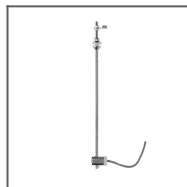

M13 Fastener set
Ref: 42611



M14 Fastener set
Ref: 42612



M3 Fastener set
Ref: 42303



M4 Fastener set
Ref: 42301



M5 Fastener set
Ref: 42302

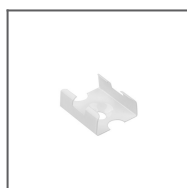

PDS Mounting
bracket
Ref: 24223

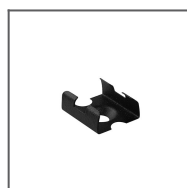

PDS Mounting
bracket
Ref: 24189

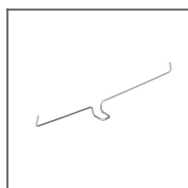

PDS Spring
Ref: 00800

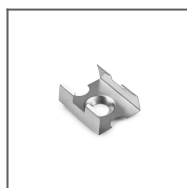

PDS-STN
Mounting bracket
Ref: 24190

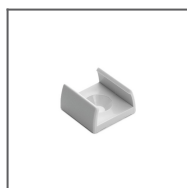

PL-PDM Mounting
bracket
Ref: 24041



PUSZ-LIN-MR
Fastener
Ref: 42258



PUSZ-PRET-MR
Fastener
Ref: 42252



REG-PD-UV
Mounting bracket
Ref: 24270



ST Head
Ref: 42216



W1 Fastener set
Ref: 42602



W10 Fastener set
Ref: 42608



W2 Fastener set
Ref: 42603

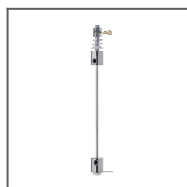

W6 Fastener set
Ref: 42604



W7 Fastener set
Ref: 42605



W9 Fastener set
Ref: 42607



ZO Head
Ref: 42217



ZZ Head
Ref: 42218

MARKETING MATERIALS



Display
P230-90082M
Ref: 90082M



Presentation set 1
Ref: 90051

LED TAPES

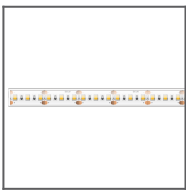

LED strip 8K-WP-
K-1275-12V
14.4W/m
Ref: 8K-WP-
K-1275-12V